

IP Camera

Quick Start Guide



User Manual

Related tools and documents are available at
<http://www.herospeed.net>.

Statement

- Thank you for using our products, please read this manual carefully before use.
- This manual is applicable to network series products.
- This manual may contain technical inaccuracies that do not correspond to the functions and operation of the product or typographical errors. The contents of this manual will be updated as product features are enhanced, and updates will be added to new versions of this manual without notice.
- If there are some differences between the description of the product in the manual and the actual product, the actual product shall always prevail.

Safety Precautions

- Please avoid installing the product in a vibration or shock environment, and keep the product away from electromagnetic interference (ignoring this may damage the product).
- In order to avoid heat accumulation, please keep good ventilation around the device, and do not block the vent of the device.
Do not install indoor products in an environment that may be exposed to water or other liquids.
- Do not use the product in extremely hot, cold, dusty, or high humidity environments.
Please store the device in a dry, non-corrosive environment and out of direct sunlight.

- Please avoid pointing the lens at strong light (such as lighting, sunlight or laser beam, etc.), otherwise it will damage the sensor.
- The power must be under safety certification, Its output voltage, current, voltage polarity and operating temperature must comply with the power requirements of this equipment.
- When using this device in thunder and lightning conditions, please pay attention to install lightning protection device or cut off the power.
- In order to get high quality video and pictures, make sure your internet connection is stable and smooth.
- The device may face network security problems when accessing the Internet, please strengthen the protection of your personal information and data security.
- Please understand that you are responsible for properly configuring all passwords and other related product security settings, and keeping your username and password properly.

Installation

Remind:

- Fix the expansion plugs to the wall first and then lock the screw if it is a concrete wall.
Install it directly with screws if it is a wooden wall.
- The installation of all control, display, recording and other terminal equipment of the camera should be smooth and easy to operate.
- All cables in the control room shall be provided with cable troughs and inlet holes according to the installation location of the equipment. They shall be arranged, bundled neatly, numbered, and permanently marked.
- The pictures in this manual are for reference only, please make the object as the standard.

Small Bullet Series

- 1 Fix the bracket to the wall with screws.

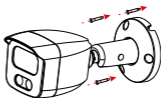

- 2 By rotating the round joint and bracket to achieve the longitudinal and axial adjustment of the camera.

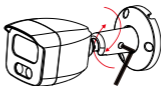

- 3 Tighten the screws with hex wrench to complete the installation.

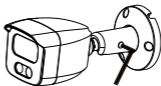

Big Bullet Series

If you have an external card slot, loosen the two screws first, remove the card cover, insert the memory card, and finally lock the card cover.

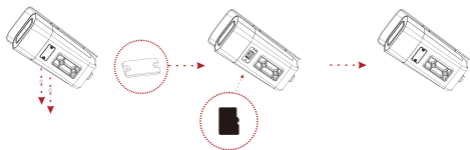

Rear Mounting Bracket Installation

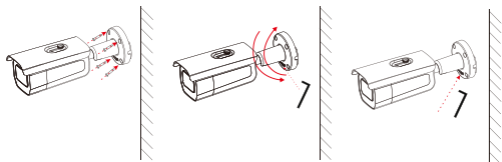

- 1 Fix the bracket to the wall with screws.
- 2 Loosen the screws with hex wrench to adjust the viewing angle.
- 3 Tighten the screws with hex wrench to complete the installation.

Bottom mounting bracket

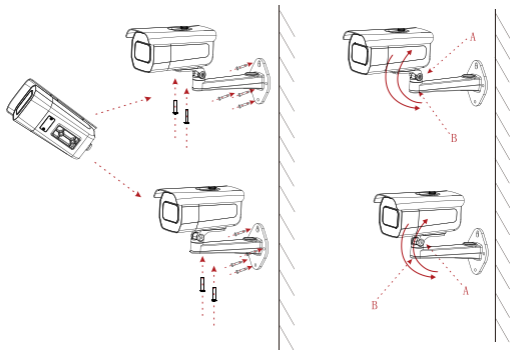

- 1 Fix the camera to the bracket with screws. The bracket head can be pre-mounted or post-mounted, and then fixed to the wall with screws.
- 2 Loosen the screws at A/B, adjust the viewing angle, tighten the screws to complete the installation.

Conch Series I



1 Remove the base.

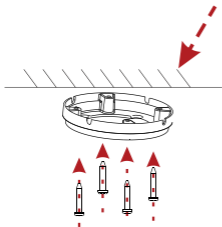

2 Fix the base to the wall with screws.

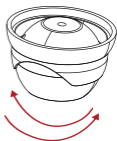

3 Rotate the sphere to a proper viewing angle.

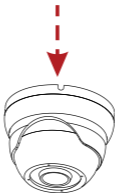

4 Rotate into the base to complete the installation.

Conch Series II

- 1 Unscrew the screws and remove the base.

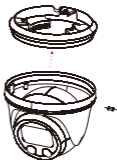

- 2 Fix the base to the wall with screws.

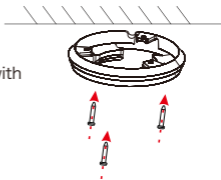

- 3 Rotate the sphere to the proper viewing angle, snap the groove of the base, and tighten the screws on the side to complete the installation.

Conch Series III

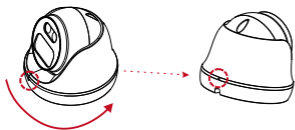

- 1 Rotate until the two triangle indicating signs overlap to remove the base.

- 2 Fix the base to the wall with screws.

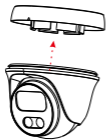
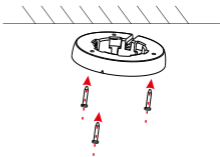

- 3 Snap the sphere into the base.



- 4 Adjust the angle: rotate the sphere to a proper viewing angle to complete installation.

Conch Series IV

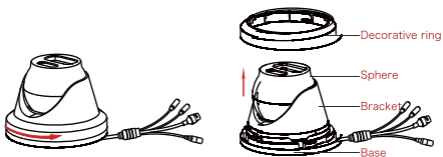

- 1 Rotate and then remove the decorative ring upward.

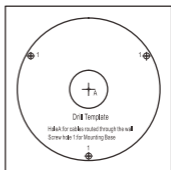

- 2 Attach the stickers on the wall in the appropriate position.

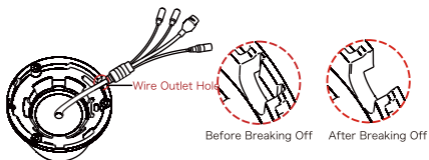

- 3 Break off the wire outlet hole on the base with dental plier and fix the wire harness to the wire outlet hole.

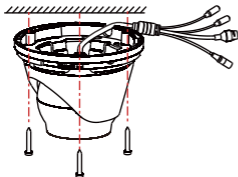

- 4 Fix the camera to the wall with screws.

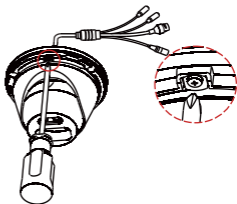

- 5 Rotate the sphere to a proper viewing angle and tighten the screws.

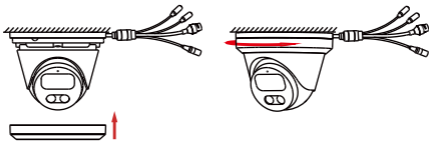

- 6 Put the decorative ring upward and rotate it tightly to complete the installation.

Small Dome Series

Fast Mounting Bracket Installation

- 1 Fix the fast mounting bracket to the wall with screws.

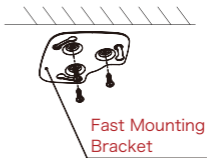

- 2 Adjust the viewing angle by rotating the sphere and then hang the camera into the quick mount bracket by rotating the body.

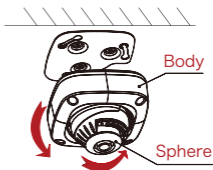

- 3 Complete the installation.

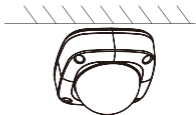

Chassis Installation

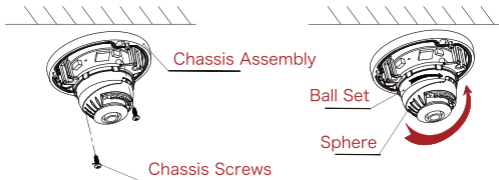

- 1 Fix the chassis assembly to the wall with screws.
- 2 Adjust the viewing angle by rotating the sphere. For certain models, it is necessary to organize the wiring independently before closing the cover to avoid affecting the appearance and functionality.

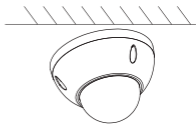
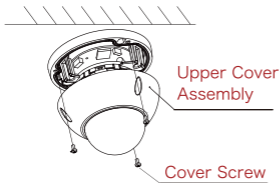

- 3 Lock the upper cover assembly to the chassis assembly with 3 screws.
- 4 Installation is complete.

Big Dome Series

Top loading

The factory default is the best angle, if you need to adjust:

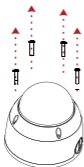

- ① Loosen 4 screws and remove the cover.

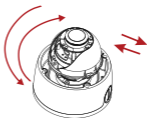

- ② Rotate the movement horizontally and vertically to adjust the angle.

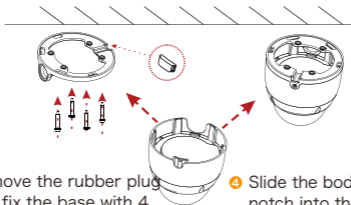

- ③ Remove the rubber plug and fix the base with 4 screws.

- ④ Slide the body into the notch into the base.

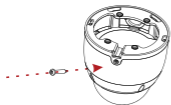

- ⑤ Screw in, fix the sphere to complete the installation.

Big Dome Series

Wall mounting

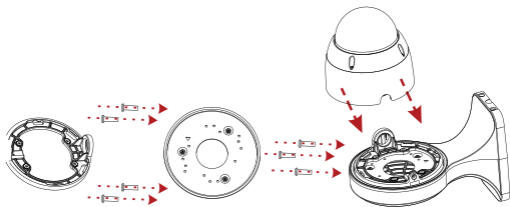

- 1 Fix the base and bracket mounting plate to the bracket body with screws.

- 2 Snap the camera body into the base.

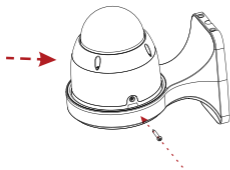

- 3 Fix the camera with screw and complete the installation.

- 4 Remove the iron plate from the bracket and fix the iron plate to the wall with 4 screws.

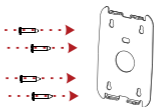

- 5 Remove the wire hole plug, put the body bracket equipped with the camera into the iron plate, and fix with 4 screws.

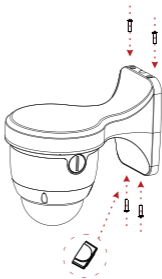

Micro Camera Series

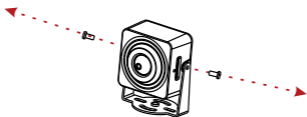

- 1 Loosen 2 screws to separate the bracket from the camera body.
-

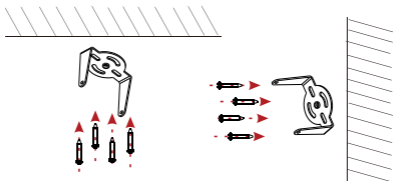

- 2 Use 4 screws to fix the bracket to the ceiling or fix it to the side wall.
-

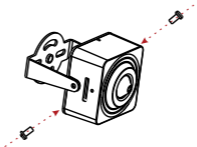

- 3 Use two screws to fix the camera body and the bracket together. Please do not tighten. Please screw on after adjusting the viewing angle.

Get Started

1. Network Setting

The default IP address of all cameras is 192.168.1.168. The IPv4 address of the computer must be in the same network segment as the IP address of the IP camera. To enable the camera to access the network smoothly, plan the available IP network segments based on the actual network environment.

Prepare the network configuration:

(1) Add the same network segment IP as 192.168.1.168 (camera factory default IP) in the computer, such as 192.168.1.165.

Steps to add an IP address to the Windows system:

Step 1: Click []Start → [Control Panel] → [Network and Sharing Center] → [Local Network] → [Properties] → [Internet Protocol Version 4 (TCP/IPv4)] → [Advanced] to enter the advanced TCP/IP setting interface.

Step 2: Click [Add] in the IP address (R) position, enter the IP address as 192.168.1.165 and the subnet mask 255.255.255.0, and click [Add] → [OK] → [OK] → [OK].

(2) Connect camera and PC by network cable in the same LAN, power on. Connecting as following (schematic diagram of the swi



The network configuration steps are as follows:

Step 1: Open [ Search Tool] (Version 7.2.45.6 and above, please install Search Tool from <http://www.herospeed.net>).

Step 2: Check 192.168.1.168.

Step 3: Modify the IP and other related network parameters on the right side of the interface

Step 4: Enter the user name (default is admin) and password (default is 123456) of the device.

Step 5: Click [Modify] → [Confirm].

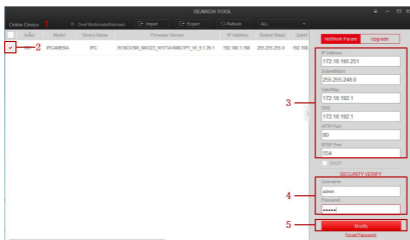

Step 6: Click [Refresh] to search for the modified IP address and the network configuration is successful.

NOTE: When configuring network parameters, ensure that the IPC address and the computer's IPv4 address are on the same network segment.

2. Modify password

Step 1: Open the IE browser, enter the IP address of IP Camera (if the IP has not been modified, please enter the default address <http://192.168.1.168>), and press [Enter].

Step 2: Enter the user name (default is admin) and password (default is 123456) of the device, and click [Login].

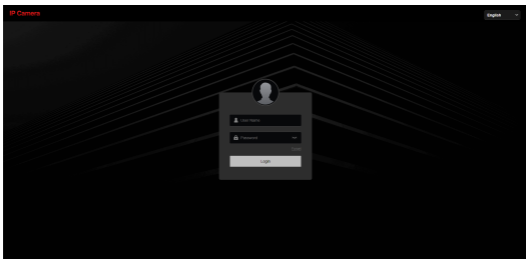

Step 3: Click [Modify], enter the password, confirm the password, set the security question, click [Export Key] → and click [OK].

Edit Users

Old Password	<input type="password"/>
User Name	<input type="text" value="admin"/>
User Type	<input type="text" value="Admin"/> ▼
Password	<input type="password"/>
Confirm Password	<input type="password"/>

The length of the password is 8 to 31 digits, and only two or more combinations of numbers, lowercase letters, uppercase letters, and special characters (-!@#%&^™_+=[,;./?) can be used

Do you want to set a new security question

Security Issue1	<input type="text"/>
Answer1	<input type="text"/>
Security Issue2	<input type="text"/>
Answer2	<input type="text"/>
Security Issue3	<input type="text"/>
Answer3	<input type="text"/>

3. Real-time preview and parameter configuration

Step 1: Click [Please download the browser plugin here, please close the browser when the download is complete], download the plug-in, close the browser, and follow the prompts to install the plug-in.

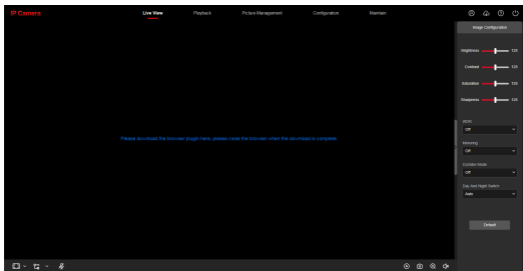

Step 2: Open the browser and log in to the IPC WEB interface again to preview the real-time video.

NOTE: If you are using a browser other than IE, you can directly enter the preview video interface without installing a plug-in.

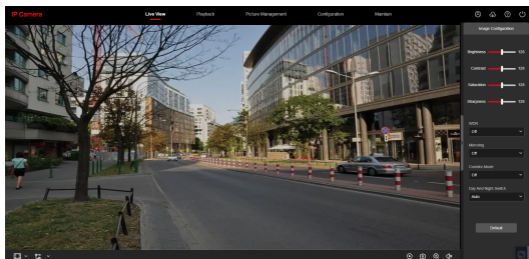

Step 3: Click [Configuration] can enter the device configuration interface, there are local configuration, system, local network, video, image, event and other functional configurations. Users can set these functions according to the actual situation of the application scenario to achieve the best monitoring effect.

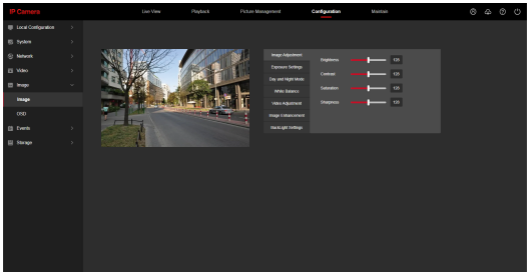

4. NVR adds IPC

Before adding devices, please make sure that the IP addresses of NVR and IPC are on the same network segment and do not conflict. Click [Configuration]→[Camera]→[Camera]→[Search] under the NVR main menu, check the devices to be added, and click [Add].

NOTE: In the main menu of NVR, you can also perform operations such as video settings, video playback, motion detection, and encoding parameter settings.

5. iVMS320 Client Access

Step 1: Open your browser and visit <http://www.herospeed.net/>.

Step 2: Click [PC Client] → [iVMS320 (Windows)] or [iVMS320 (Mac)] to download the latest version of the video management system [iVMS320].

Step 3: Follow the prompts to install and add devices for viewing and management.

6. Mobile App Access

Scan the QR code below to download and install the BitVision App.



After registering and logging in, you can add the device, and remotely view and manage the device on the mobile phone.

Disclaimer

The following exemptions or limitations of liability, please pay special attention to:

- The Company shall not be liable to you or any third party for any personal injury or property damage if the product is discontinued or the service is terminated for any of the following reasons: failure to install or use the product in strict accordance with the requirements; for the protection of the national or public interest; force majeure; or for your own or third party's reasons (including, but not limited to, problems with the use of third party products, software or components.
- The Company does not warrant in any way, express or implied, that this product is fit for a particular purpose or use. This product shall not be used in medical, safety equipment or other applications where the failure of the product could result in life threatening or personal injury and in weapons of mass destruction, biological and chemical weapons. The use of the site for hazardous or inhumane purposes, such as nuclear weapons, nuclear explosions or any unsafe use of nuclear energy. Any loss or liability arising from such use will be borne by you.
- This product, when properly installed and used, can detect a break-in in a specific area, but it cannot prevent an accident or the resulting personal injury or property damage. You should be vigilant in your daily life and be aware of safety precautions.
- The company shall not be liable for any indirect, incidental, special or punitive damages, claims, property damage or loss of any data or files. To the maximum extent permitted by law, none of our liability will exceed the amount you paid for this product.